



**Miscellaneous  
Bolts**

---

<b>C</b>
Carriage Bolts D-3

---

<b>E</b>
Elevator Bolts D-2

---

<b>J</b>
J-Bolts D-7

---

<b>L</b>
Lag Screws D-4

---

<b>P</b>
Plow Bolts
Grade 5 D-7
Grade 8 D-5

---

<b>S</b>
Shaker Screen Bolts D-8
Step Bolts D-2

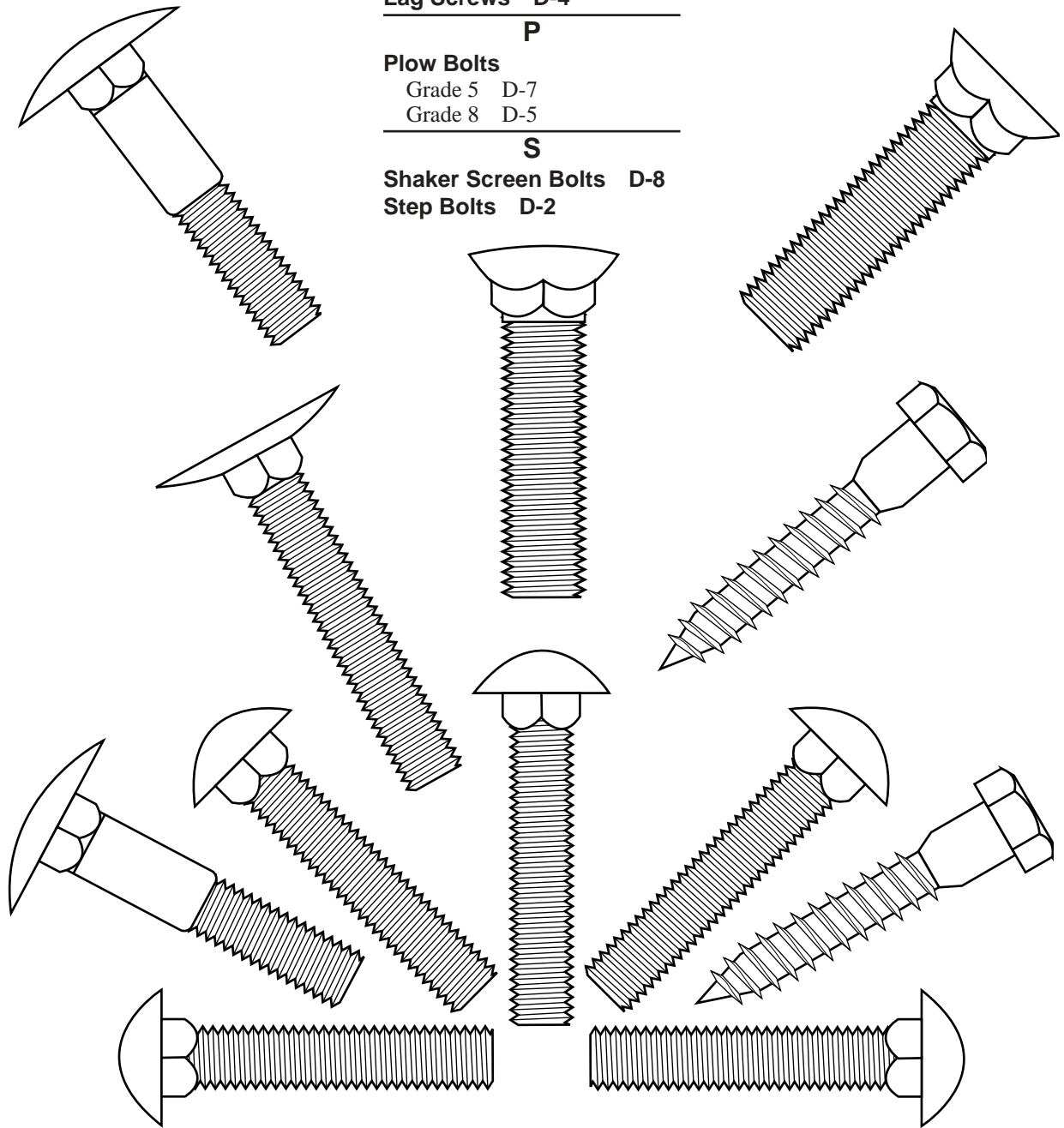

**M  
I  
S  
C  
E  
L  
L  
A  
N  
E  
O  
U  
S  
B  
O  
L  
T  
S**



**IBS, INCORPORATED**  
**Step Bolts D01 & Elevator Bolts D02**

**M  
I  
S  
C  
E  
L  
L  
A  
N  
E  
O  
U  
S  
B  
O  
L  
T  
S**

## Step Bolts

- Zinc plated to protect against corrosion

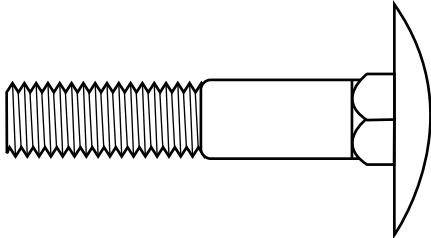

### Features

- Large full head
- Full formed square neck
- Clean sharp rolled threads

1/4-20			5/16-18			3/8-16		
IBS No.	Length	Qty	IBS No.	Length	Qty	IBS No.	Length	Qty
<b>3241</b>	1"	100	<b>3253</b>	1-1/2"	50	<b>3261</b>	1-1/2"	50
<b>3242</b>	1-1/4"	100						

## Elevator Bolts

- Ideal for conveyors, machine repair & bowling alley sweeps
- Zinc plated to protect against corrosion

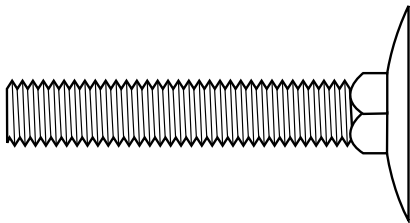

### Features

- Large round head
- Full formed square neck
- Clean sharp rolled threads

1/4-20			5/16-18			3/8-16		
IBS No.	Length	Qty	IBS No.	Length	Qty	IBS No.	Length	Qty
<b>3266</b>	1"	100	<b>3276</b>	1"	50	<b>3287</b>	1-1/2"	50
<b>3267</b>	1-1/4"	100	<b>3278</b>	1-1/2"	50			
<b>3268</b>	1-1/2"	100	<b>3280</b>	2"	50			
<b>3269</b>	2"	100	<b>3281</b>	2-1/2"	50			



# Carriage Bolts

- Zinc plated to protect against corrosion.
- Square, sharp neck prevents bolt from turning when nut is tightened.
- Large, round head.

10-24 (3/16")			1/4-20			5/16-18		
IBS No.	Length	Qty	IBS No.	Length	Qty	IBS No.	Length	Qty
<b>3300</b>	3/4"	100	<b>3308</b>	3/4"	100	<b>3330</b>	3/4"	100
<b>3301</b>	1"	100	<b>3309</b>	1"	100	<b>3331</b>	1"	100
<b>3302</b>	1-1/4"	100	<b>3310</b>	1-1/4"	100	<b>3332</b>	1-1/4"	100
<b>3303</b>	1-1/2"	100	<b>3311</b>	1-1/2"	100	<b>3333</b>	1-1/2"	100
			<b>3312</b>	1-3/4"	100	<b>3335</b>	2"	100
			<b>3313</b>	2"	100	<b>3337</b>	2-1/2"	100
			<b>3315</b>	2-1/2"	100	<b>3339</b>	3"	100
			<b>3317</b>	3"	100	<b>3340</b>	3-1/2"	50
			<b>3318</b>	3-1/2"	100	<b>3341</b>	4"	50
			<b>3319</b>	4"	100			

3/8-16			1/2-13		
IBS No.	Length	Qty	IBS No.	Length	Qty
<b>3352</b>	1"	100	<b>3382</b>	1-1/2"	50
<b>3353</b>	1-1/4"	100	<b>3383</b>	1-3/4"	50
<b>3354</b>	1-1/2"	100	<b>3384</b>	2"	50
<b>3355</b>	1-3/4"	100	<b>3386</b>	2-1/2"	50
<b>3356</b>	2"	100	<b>3388</b>	3"	50
<b>3358</b>	2-1/2"	50	<b>3389</b>	3-1/2"	25
<b>3360</b>	3"	50	<b>3390</b>	4"	25
<b>3361</b>	3-1/2"	50	<b>3392</b>	5"	25
<b>3362</b>	4"	50			

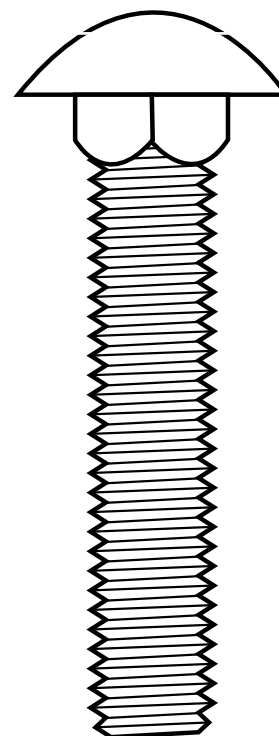

**M  
I  
S  
C  
E  
L  
L  
A  
N  
E  
O  
U  
S  
B  
O  
L  
T  
S**



# IBS, INCORPORATED

## Lag Screws D04

**M  
I  
S  
C  
E  
L  
L  
A  
N  
E  
O  
U  
S  
  
B  
O  
L  
T  
S**

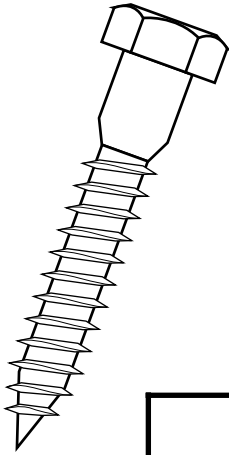

### Lag Screws

- Zinc plated to protect against corrosion
- Accepts any standard wrench
- Clean well formed threads
- Deep threads with wide pitch
- Cleanly trimmed head

1/4"			5/16"		
IBS No.	Length	Qty	IBS No.	Length	Qty
<b>3500</b>	1"	100	<b>3513</b>	1"	100
<b>3502</b>	1-1/2"	100	<b>3517</b>	1-1/2"	100
<b>3504</b>	2"	100	<b>3519</b>	2"	100
<b>3505</b>	2-1/2"	100	<b>3520</b>	2-1/2"	100
<b>3506</b>	3"	100	<b>3521</b>	3"	100
<b>3507</b>	3-1/2"	100	<b>3522</b>	3-1/2"	50
<b>3508</b>	4"	100	<b>3523</b>	4"	50

3/8"			1/2"		
IBS No.	Length	Qty	IBS No.	Length	Qty
<b>3530</b>	1"	100	<b>3546</b>	1-1/2"	50
<b>3532</b>	1-1/2"	100	<b>3547</b>	2"	50
<b>3534</b>	2"	100	<b>3548</b>	2-1/2"	50
<b>3535</b>	2-1/2"	50	<b>3549</b>	3"	50
<b>3536</b>	3"	50	<b>3550</b>	3-1/2"	25
<b>3537</b>	3-1/2"	50	<b>3551</b>	4"	25
<b>3538</b>	4"	50	<b>3553</b>	5"	25
<b>3540</b>	5"	50	<b>3555</b>	6"	25
<b>3542</b>	6"	50			

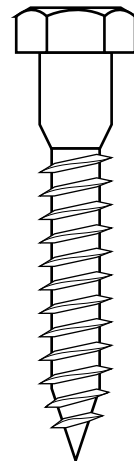



# Plow Bolts Grade 8

## No. 3 Round Head with Extra-Thick Dome

- 150,000 psi minimum tensile strength.
- Domed head for greater resistance to abrasion and “pull-through”.
- Will not “freeze-up”.
- Can be quickly and easily removed and re-used.
- Exclusive Bronze-Bond finish resists rust and corrosion.
- Meets or exceeds all O.E.M. specifications.

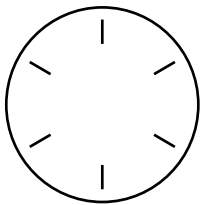

Domed Head

- Greater resistance to wear & abrasion
- Will not pull through the blade

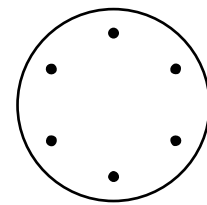

Branded Head

- Positive quality identification

### Sharp Square Shoulders

- Prevents turning in the blade

### U.S.S. Threads

- Resists nicks

### Chamfered Ends

- Trouble free assembly

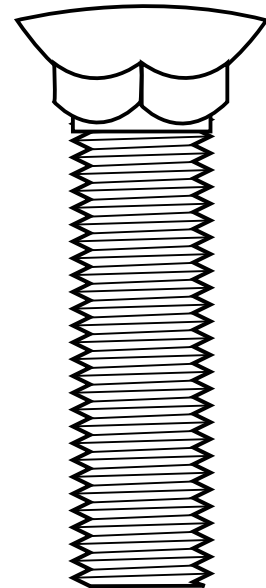

## Industrial Sizes for Construction Equipment

**M  
I  
S  
C  
E  
L  
L  
A  
N  
E  
O  
U  
S  
  
B  
O  
L  
T  
S**



**IBS, INCORPORATED**  
Plow Bolts Gr. 8 D05

**Plow Bolts Grade 8**

**M  
I  
S  
C  
E  
L  
L  
A  
N  
E  
O  
U  
S  
  
B  
O  
L  
T  
S**

5/8-11			3/4-10			7/8-9		
IBS No.	Length	Qty	IBS No.	Length	Qty	IBS No.	Length	Qty
3602	2"	25	3613	2"	20	3632	2-1/2"	10
3603	2-1/4"	25	3614	2-1/4"	20	3633	2-3/4"	10
3604	2-1/2"	25	3615	2-1/2"	20	3634	3"	10
3605	2-3/4"	25	3616	2-3/4"	20	3637	3-1/2"	10
3606	3"	25	3617	3"	20	3639	4"	10
3607	3-1/2"	25	3619	3-1/2"	20			
			3621	4"	20			
			3622	4-1/2"	20			
			3623	5"	20			

1"-8		
IBS No.	Length	Qty
3645	2-1/2"	10
3646	2-3/4"	10
3647	3"	10
3648	3-1/4"	10
3649	3-1/2"	10
3651	4"	10
3652	4-1/2"	10
3653	5"	10

1-1/4"-7		
IBS No.	Length	Qty
3656	3"	10
3660	3-3/4"	10
3661	4"	10

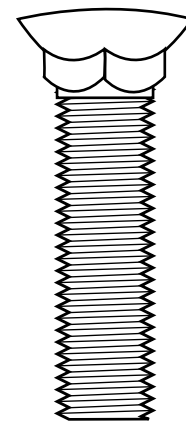
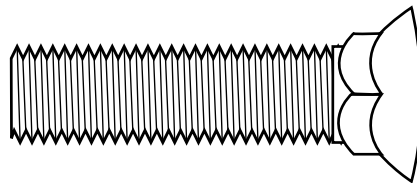
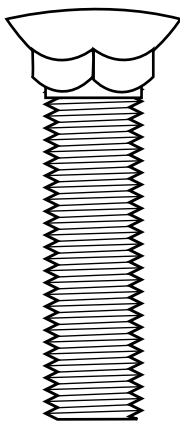



## Plow Bolts Grade 5

For use on farm machinery and industrial equipment where smaller diameter plow bolts are used.

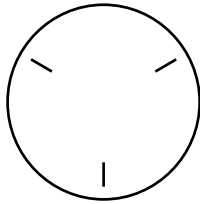

- **140,000 psi Tensile Strength.**
- **Hardened sharp square corners to prevent turning in the blade.**
- **Clean, sharp burr free threads.**

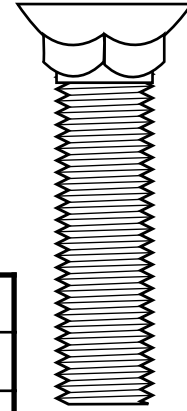

3/8-16		
IBS No.	Length	Qty
3670	1-1/2"	100

1/2-13		
IBS No.	Length	Qty
3673F	1-1/2"	10
3673G	1-3/4"	10
3674	2"	10
3675	2-1/2"	10

## J-Bolts

**N.C. Thread**

**\* For Shaker Screen Applications \***  
**Manufactured from Carbon Steel**

Carbon Steel "J" Bolts				
IBS No.	Dia.	Length	Thread Length	Pkg Qty
3750	1/2-13	5"	3-1/2"	25
3752	1/2-13	6"	3-1/2"	25

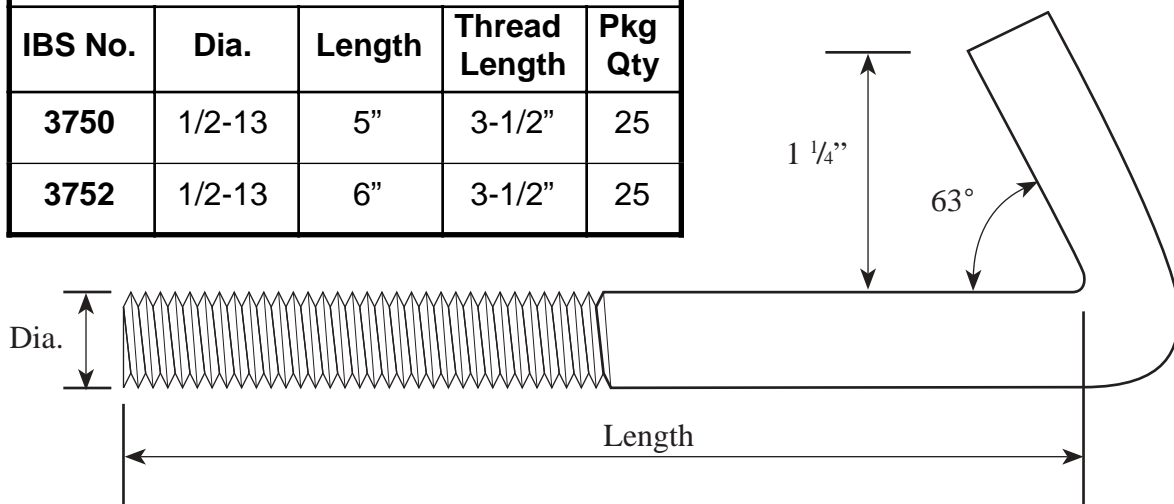



**IBS, INCORPORATED**  
**Shaker Screen Bolts D06**

**M  
I  
S  
C  
E  
L  
L  
A  
N  
E  
O  
U  
S  
B  
O  
L  
T  
S**

**Shaker Screen Bolts**  
**(Heat Treated Carriage Bolts)**

- 125,000 psi minimum tensile strength.
- Made of special alloy steel.
- Fully threaded.
- Reduces wear and eliminated breakage.
- Triple heat treated and stress relieved for increased life.
- Ideal for use in mines, concrete plants, quarries, etc.

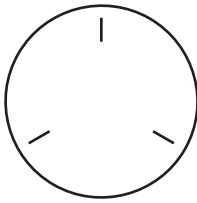

Concentric heads for better bearing starting point.

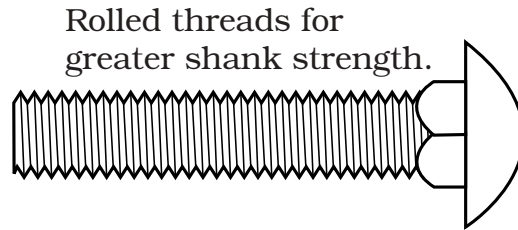

Rolled threads for greater shank strength.

Chamfered easy Controlled radii under the head for increased head strength.

Sharp square shoulders under the head for positive seating.

1/2-13			5/8-11			3/4-10		
IBS No.	Length	Qty	IBS No.	Length	Qty	IBS No.	Length	Qty
3700	1-1/2"	50	3711	2-1/2"	25	3722	4"	20
3701	2"	50	3713	3"	25	3723	4-1/2"	20
3702	2-1/2"	25	3714	3-1/2"	25	3724	5"	20
3703	3"	25	3715	4"	25	3726	6"	20
3704	3-1/2"	25	3716	4-1/2"	25			
3705	4"	25	3717	5"	25			
3706	5"	25	3718	6"	20			
3708	6"	25						